



PS-DC-DUAL-5624T

345 Watt Isolated Power Supply with 56VDC and 24 VDC Dual Output

Install Guide



Contents

- 1. Introduction.....1**
 - Ordering Information 2
 - Features..... 2
 - Specifications 3
 - Power Cord Specifications..... 4
 - Connectors and LEDs..... 7
 - Dimensions..... 8
 - Power Cords 8
 - Front Panel Descriptions 9
- 2. Installation.....10**
 - Cautions and Warnings 10
 - Unpacking 11
 - Mounting..... 12
 - Grounding 12
 - Connecting POWER OUTPUT 12
 - Connecting AC INPUT 12
 - PWR (Power) LED 13
 - Fuse Replacement..... 13
 - Installing TN 16210 Ferrite 13
 - Related Manuals 14
 - For More Information 14
 - Application Example..... 14
- 3. Related Information15**
 - Troubleshooting 15
 - Compliance Information 15
 - Electrical Safety Warnings..... 16
 - Warranty 16
 - Product Label and Box Label 17
 - Contact Us..... 18
 - Record of Revisions 18

1. Introduction

The Power Supply provides 345W at 56VDC and is targeted for PoE applications. The Power Supply is fully compliant with IEEE 802.3af, at, and bt PoE standards for isolation. It provides a secondary fully-isolated 24V at 1.25A (30W) output for other equipment.

Ordering Information

Model	Description
PS-DC-DUAL-5624T	Hardened 345 Watt Isolated Power Supply with 56VDC and 24VDC Dual Output
PS-DC-DUAL-5624T-AL	Hardened 345 Watt Isolated Power Supply with 56VDC and 24VDC Dual Output with Locked –NA Power Cord
27274	AC Power Cord with locking; -NA Line Cord
3344	AC Power Cord; non-locking; -NA Line Cord
27275	AC Power Cord with locking; -NA Line Cord, Right angle

Features

- Wide 100-240VAC input with externally accessible fuse
- 56 VDC output provides plenty of margin for the powered device (PD) to meet minimum PSE output voltage requirements:
 - IEEE 802.3af (44VDC, 12V margin)
 - IEEE 802.3at (50VDC, 6V margin)
 - IEEE 802.3bt (52VDC, 4V margin)
- Desktop mountable / DIN rail form factor
- Full compliance with the IEEE 2250 VDC PoE isolation requirements
- Active fan speed control based on temperature (PWM)
- Front panel LED for power supply status (Normal and Alarm)
- 2-Pin Alarm DC relay output monitoring five events:
 - Fan tachometer monitoring for low speed and lock conditions
 - Over- or under-temperature
 - 24V output out of spec
- UL approval
- 5 year warranty

Specifications

Output 1	Voltage 56V (terminal block) Regulation +/- 2% Current Rating 5.7A Power Rating 315W
Output 2	Voltage 24V (terminal block) Regulation +/- 5% Current Rating 1.25A Power Rating 30W
Input Voltage Range	100-240VAC
Input Frequency Range	47 - 63 HZ
Power Consumption	4.0A at 120VAC typical
Dimensions (HxWxD)	Width: 6.25" [159 mm] x Depth: 6.45" [164 mm] x Height: 1.75" [44 mm]
Weight	1.8 lbs. (0.72Kg)
Environment	Operating Temp.: -20°C to +70°C (restricted); -20°C to +50°C (unrestricted) Storage Temp.: -30°C to +70°C Operating Humidity: 5% to 95% (non-condensing)
Alarm output rating	30VDC maximum 50mA maximum
MTBF	623,377 hrs. ENV: GB TEMP: 30.00 deg. C TELCORDIA CALCULATION METHOD: Parts Count (Method I)
Certifications	EMI: EN55032 Class A, EN55024 Safety: EN60950, UL 60950
Warranty	Five years

Power Cord Specifications

Power cord specifications are provided below.

27275 AC Power Cord with locking; -NA Line Cord, Right angle

Connectors: NEMA 5-15P
IEC-60320-C13
Length: 3 ft. (0.91 m)
Gauge: 18
Jacket Type: SJTW 105°C
Rating: 10A – 125V
Safety: UL

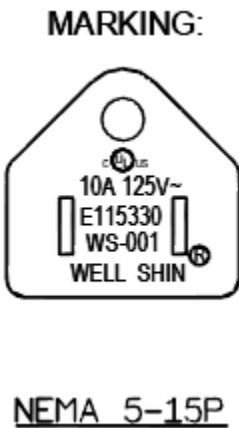
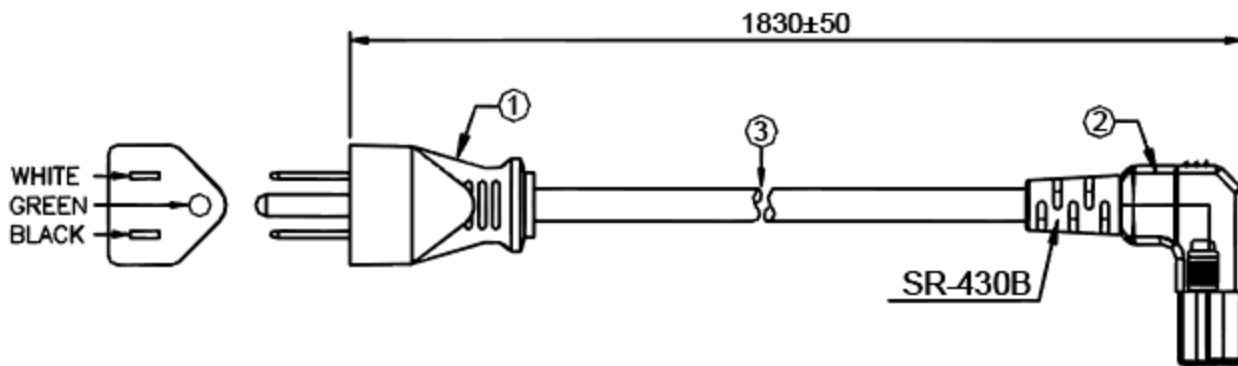

27274 AC Power Cord with locking; -NA Line Cord

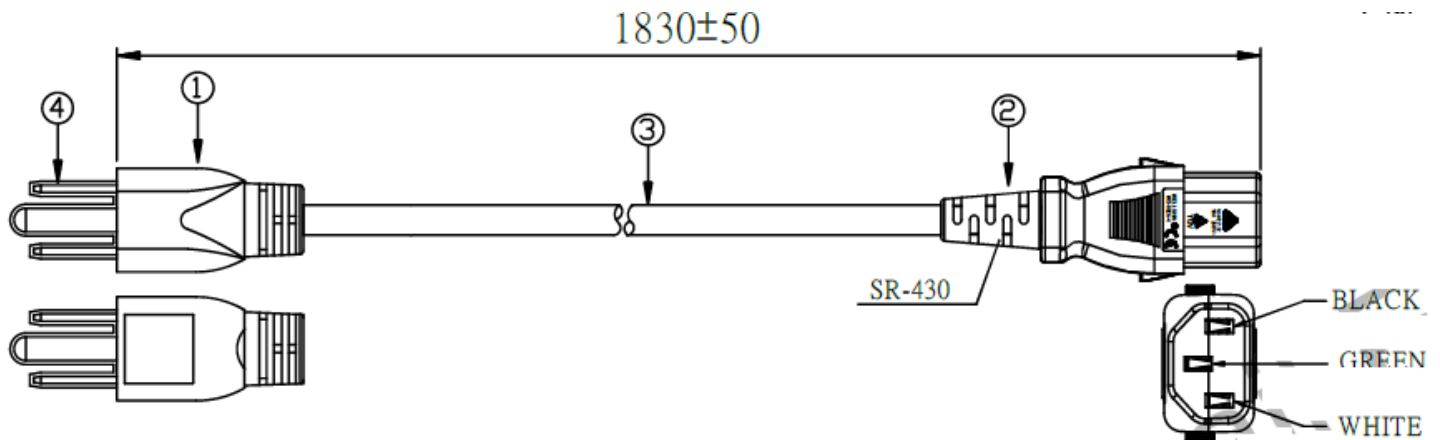

MARKING:

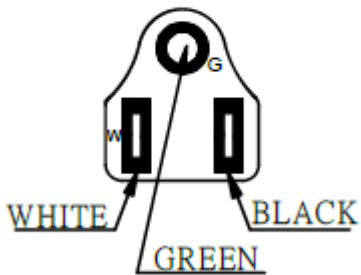
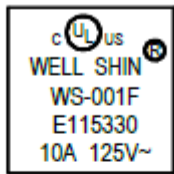

NEMA 5-15P

MARKING:

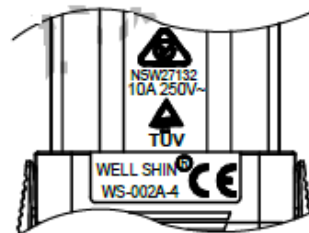

upper cover

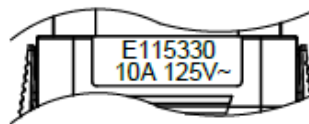

Lower lid

IEC-60320-C13
AUTO-LOCK

3344 AC Power Cord; non-locking; -NA Line Cord

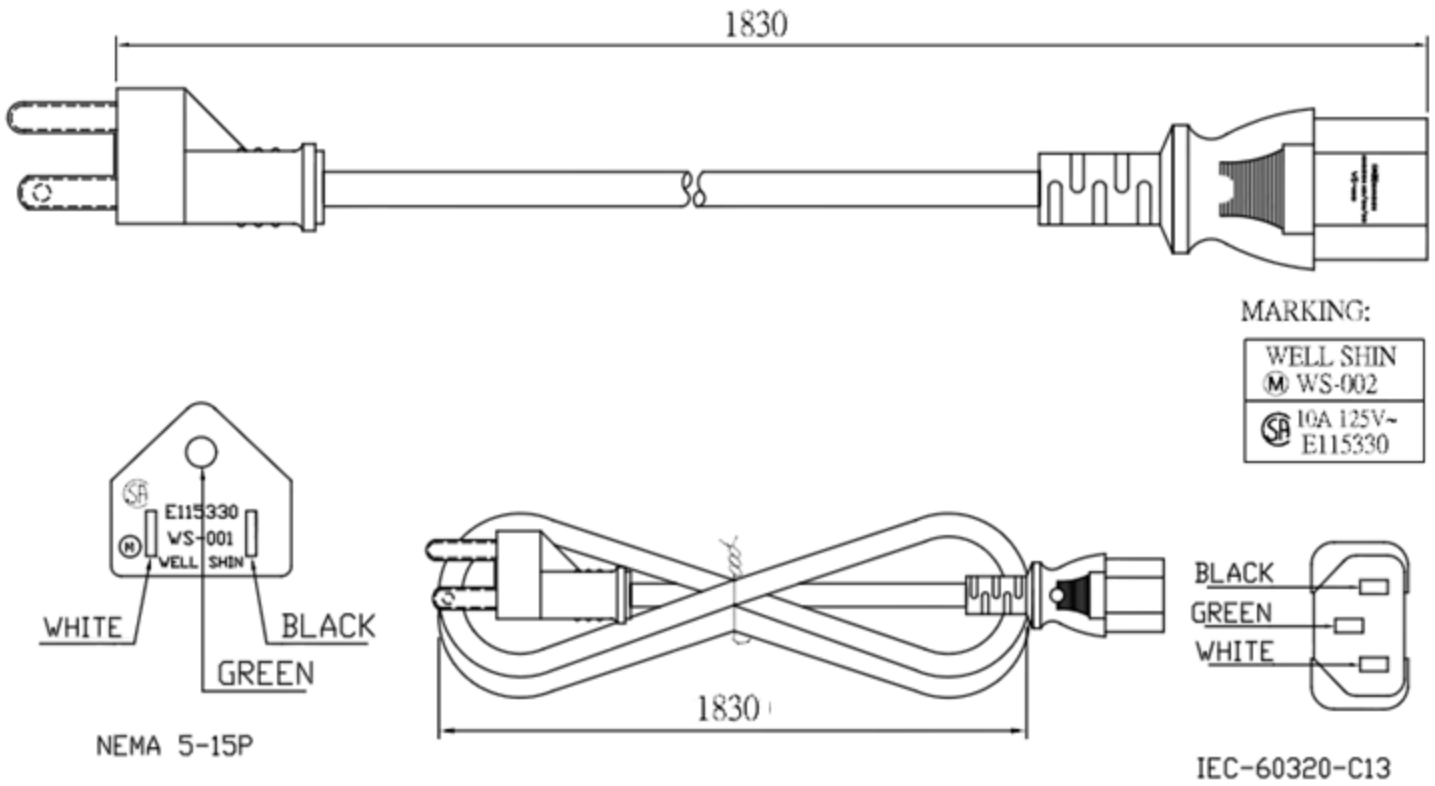

Connectors and LEDs

AC Input

- Connector: IEC C14
- Fuse: 6.3A slo blo
- Power On/Off switch

56VDC and 24VDC output: 6-Pin Terminal Block

- Pin 1: 24Vout+
- Pin 2: 24Vout-
- Pin 3: Alarm Contacts 1
- Pin 4: Alarm Contacts 2
- Pin 5: 56Vout+
- Pin 6: 56Vout-

LEDs

- Power status
 - Green: OK
 - Yellow blink: Will cycle through if one or more events (alarms) occur with one of these Blink Rates:
 - 1 blink per 3 seconds: Fan locked (no tach)
 - 2 blinks per 3 seconds: Fan less than 30% PWM (Pulse Width Modulation) setting
 - 3 blinks per 3 seconds: 24VDC output out of spec
 - 4 blinks per 3 seconds: Exceeding -25 Deg. C
 - 5 blinks per 3 seconds: Exceeding +75 Deg. C

If more than one alarm is set the LED will cycle through the Blink Rates one at a time, and then repeat until the alarm is cleared.

Note: These Blink Rates include a 3 second alarm delay to prevent triggering a false alarm when the fan ramps up or down.

Dimensions

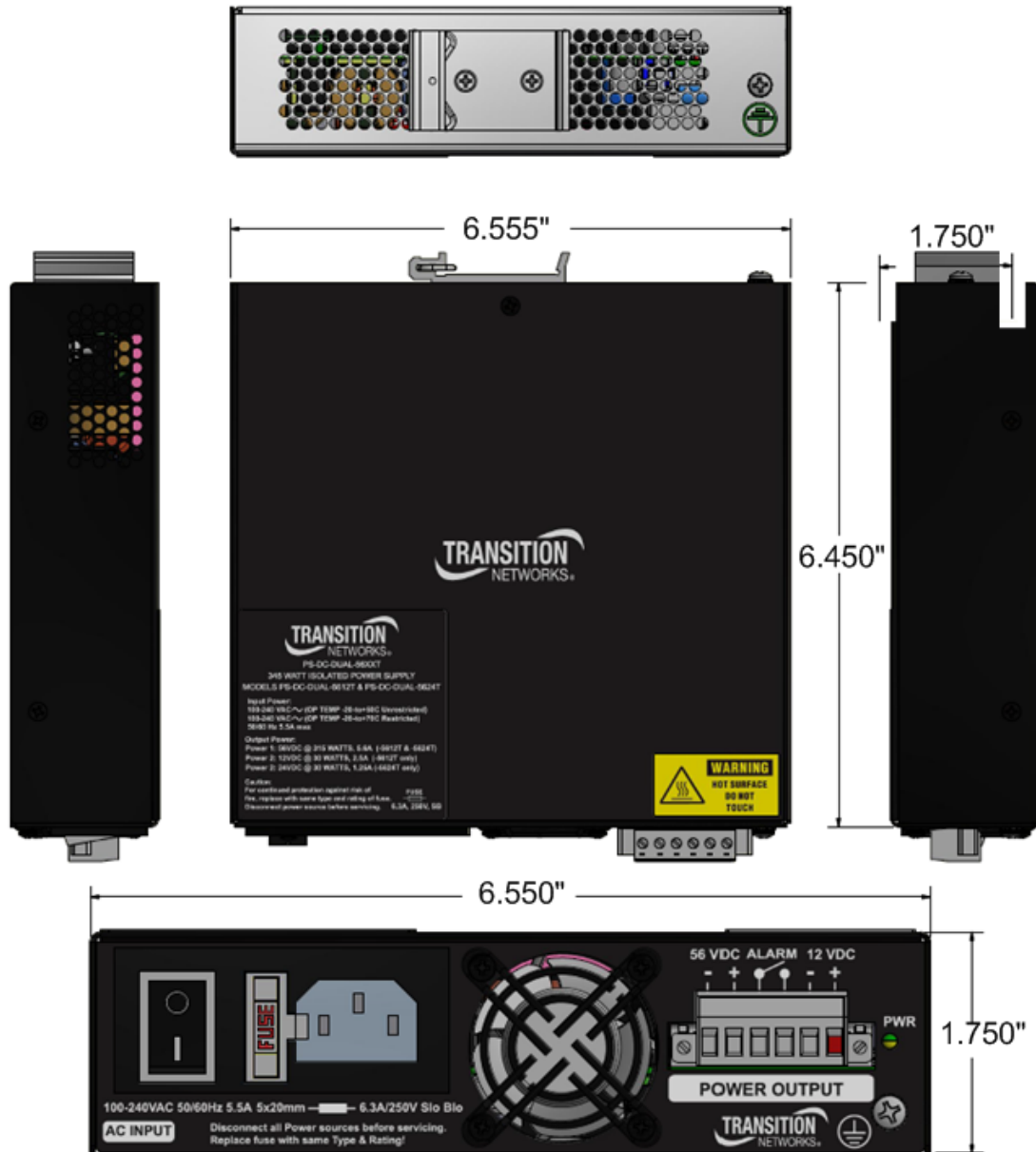

Power Cords

Locking and non-locking line cords are available.

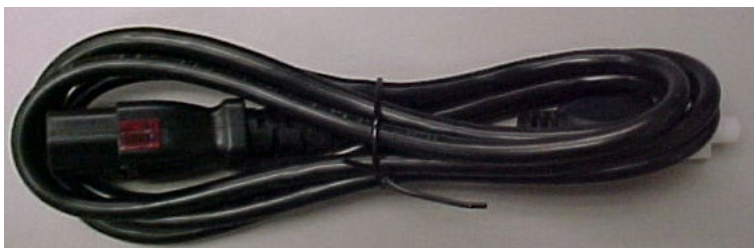

AC Power Cord with locking; -NA Line Cord



AC Power Cord with locking; -NA Line Cord, Right angle

Front Panel Descriptions

The Power Supply front panel is shown and described below. See the Installation section for the actual grounding and connection procedures.



PS-DC-DUAL-5624T Hardened 345 Watt Isolated Power Supply with 56VDC and 24VDC Dual Output

On / Off switch: The power on/power off switch is labeled **O** (off) / **|** (on).

FUSE: The fuse can be replaced without opening the chassis; see [Fuse Replacement](#) below.

AC INPUT Power connection: labeled 100-240VAC 50/60 Hz; see [Connecting AC INPUT](#) below.

POWER OUTPUT Terminal Block: labeled 56 VDC - and +, ALARM, and 24 VDC - and +. See [Connecting POWER OUTPUT](#) below.

PWR (Power) Status LED: a bi-color green/amber LED; Green = OK, Yellow blink = Fault Event Detected (see [LED Blink Rate](#) above).



2. Installation

Cautions and Warnings

Cautions and Warnings appear here and may appear throughout this manual where appropriate. Failure to read and understand the information identified by this symbol could result in poor equipment performance, damage to the equipment, or injury to persons.

Cautions indicate that there is the possibility of poor equipment performance or potential damage to the equipment. Warnings indicate that there is the possibility of injury to person.

See [Electrical Safety Warnings](#) on page 16 for Electrical Safety Warnings translated into multiple languages.

High Risk Activities Disclaimer: Components, units, or third-party products used in the product described herein are NOT fault-tolerant and are NOT designed, manufactured, or intended for use as on-line control equipment in the following hazardous environments requiring fail-safe controls: the operation of Nuclear Facilities, Aircraft Navigation or Aircraft Communication Systems, Air Traffic Control, Life Support, or Weapons Systems ("High Risk Activities"). Transition Networks and its supplier(s) specifically disclaim any expressed or implied warranty of fitness for such High Risk Activities.

Notice: Not Designed for Use in Life Support Equipment or Applications: These products are not designed for use in life support equipment or applications that would cause a life-threatening situation if any such product failed. Do not use this product in these types of equipment or applications.

Operating Temperature - RESTRICTED ACCESS LOCATION: A location for equipment where both of the following paragraphs apply:

- access can only be gained by SERVICE PERSONS or by USERS who have been instructed about the reasons for the restriction applied to the location and about any precautions that shall be taken; and
- access is through the use of a TOOL or lock and key, or other means of security, and is controlled by the authority responsible for the location.

NOTE: The requirements for equipment intended for installation in RESTRICTED ACCESS LOCATIONS are the same as for OPERATOR ACCESS AREAS, except as given in 1.7.17, 2.1.3 and 4.5.1.

1.2.7.4 TOOL: A screwdriver or any other object which may be used to operate a screw, latch or similar fixing means.

1.2.7.5 BODY: All accessible conductive parts, shafts of handles, knobs, grips and the like, and metal foil in contact with all accessible surfaces of insulating material.

1.2.7.6 SAFETY INTERLOCK: A means either of preventing access to a hazardous area until the hazard is removed, or of automatically removing the hazardous condition when access is gained.

WARNING
HOT SURFACE
DO NOT
TOUCH



Input Power:

100-240 VAC ~ (Operating Temperature -20 to +50°C Unrestricted)

100-240 VAC ~ (Operating Temperature -20 to +70°C Restricted)

50/60 Hz 5.5A max

Output Power:

Power 1: 56VDC @ 315 Watts, 5.6 Amps

Power 2: 24VDC @ 30 Watts, 1.25 Amps

Unpacking

Carefully unpack the Power Supply. Verify you have received the items below. Save the packaging for possible future use.

- One Power Supply
- One Postcard
- One printed Quick Start Guide, 33792
- One AC Power Cord (option)
- Four Rubber Feet
- One Snap-on Ferrite, TN 16210



Mounting

Desktop: You can attach the four adhesive-backed rubber feet to the bottom of the power supply for desktop mounting.

DIN Rail: The power supply ships with a rack DIN rail bracket attached. **Caution:** If mounted in a NEMA rated enclosure, either vertical direction is allowed. In a standard 19" rack, the side holes must face upward. To attach the power supply to a DIN rail:

1. General caution for Thermals: Make sure there is at least 2 inches of open space outside of at least one of the two vented sides. See below.
2. Hang the top of the DIN rail bracket on the DIN rail. **Caution:** The DIN Rail Spring Clip must be facing upwards, as shown below.
3. Click the bottom of the DIN rail bracket onto the DIN rail.

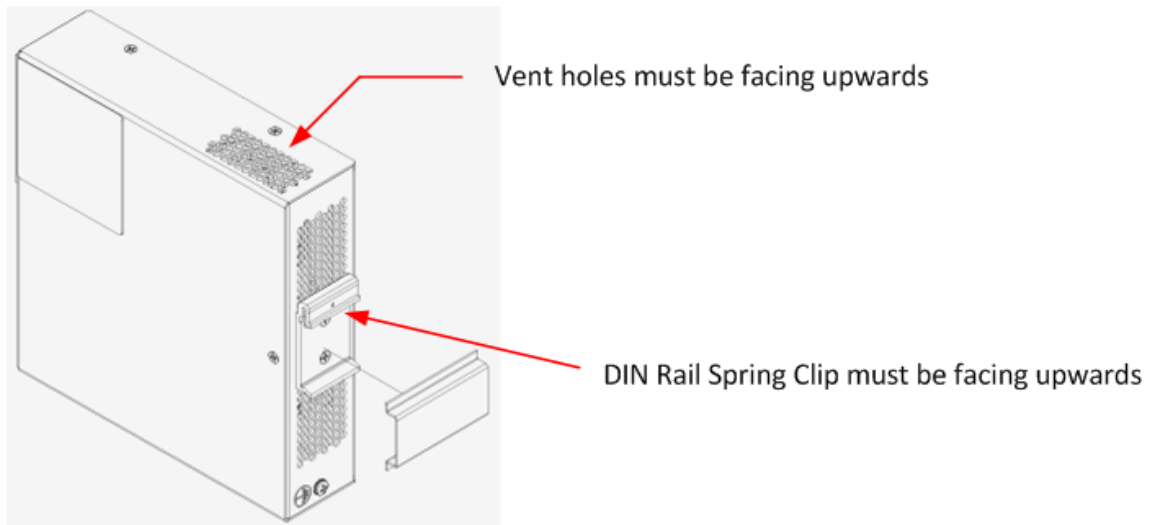

Caution: If mounted in a NEMA rated enclosure, either vertical direction is allowed. If mounted in a standard 19" rack, the side holes must face upward.

General caution for Thermals: Make sure there is at least 2 inches of open space outside of at least one of the two vented sides.

Caution: The DIN Rail Spring Clip must be facing upwards, as shown below.

Grounding



Connecting POWER OUTPUT

Use 14 AWG stranded or better wire (typ.) to connect to 56 VDC@315W.

Use 20 AWG stranded or better wire (typ.) to connect to 24 VDC@30W.

Refer to the powered device documentation for specific connection information; see the [Related Manuals](#) section below.

Connecting AC INPUT

Connect the male end of the provided AC power cord to the power supply AC input first, and then connect the other end to a live 3-prong outlet.

PWR (Power) LED

When the bi-color green/yellow **PWR** LED is lit Green, the power being supplied is OK.

If the bi-color green/yellow LED is blinking yellow, a fan, voltage, or temperature event is occurring.

Fuse Replacement

The AC INPUT is 100-240VAC 50/60Hz 5.5A. The Fuse is a 5x20mm 6.3A/250V SB (slo blo) externally-accessible fuse.

Warning: Disconnect all Power sources before servicing.

Caution: Replace fuse with same Type & Rating!

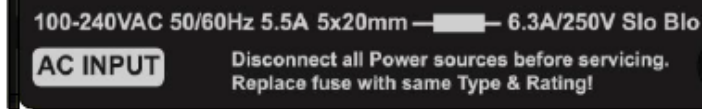

Installing TN 16210 Ferrite

For EMC reasons, install Snap-on Ferrite, TN 16210, over the 24 VDC (PS-DC-DUAL-5624T) output wires after installation.

1. Open Ferrite.
2. Place the Ferrite over the 24 VDC Outputs.
3. Snap Ferrite in place.

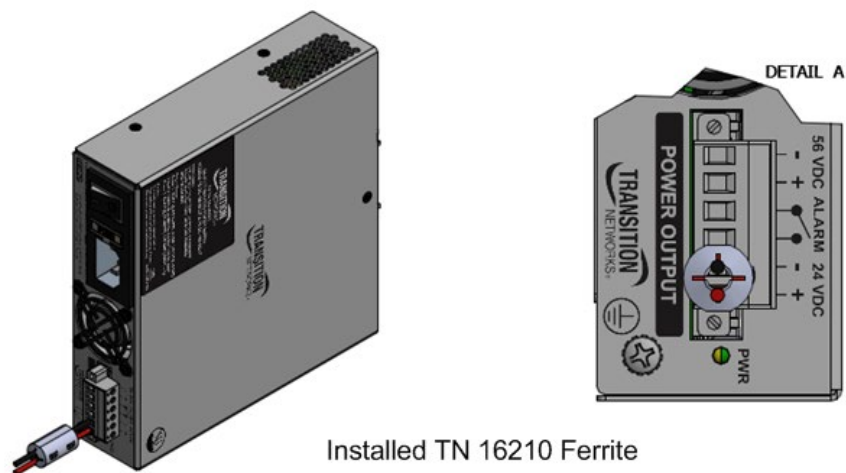
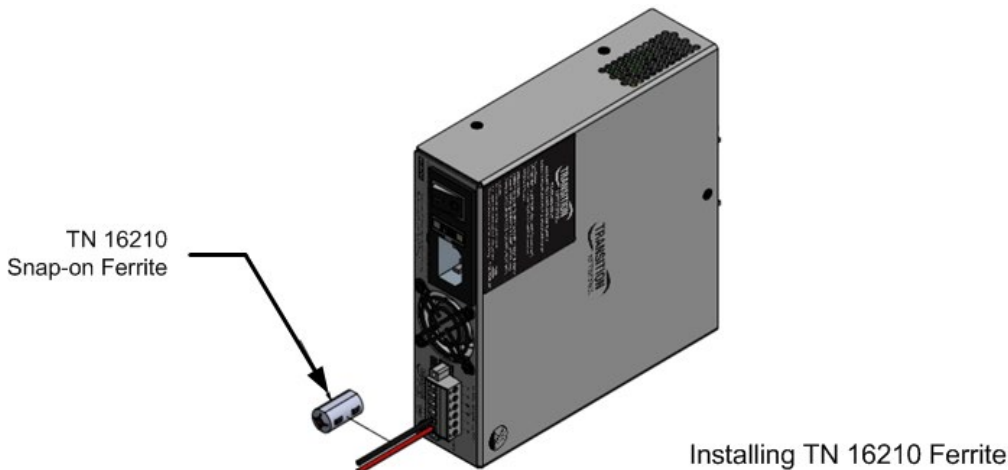

Related Manuals

- PS-DC-DUAL-5624T Power Supply Quick Start Guide, 33792
- Quick Start Guide - SISPM1040-384-LRT-C and SISPM1040-362-LRT, 33726
- Install Guide - SISPM1040-384-LRT-C and SISPM1040-362-LRT, 33727
- Web User Guide - SISPM1040-384-LRT-C and SISPM1040-362-LRT, 33728
- CLI Reference - SISPM1040-384-LRT-C and SISPM1040-362-LRT, 33729

For More Information

For Transition Networks Drivers, Firmware, etc. go to the [Product Support](#) webpage (logon required).

For Transition Networks Manuals, Brochures, Data Sheets, etc. go to the [Support Library](#) (no logon required).

Note: Information in this document is subject to change without notice. Note that this manual provides links to third party web sites for which Transition Networks is not responsible.

Application Example: The example below shows a SISPM1040-384-LRT-C switch, Enclosure Door sensor, and PS-DC-DUAL-5624T power supply in a single cabinet/enclosure. **Warning:** Ensure that the target alarm input is capable of accepting the applied voltage (24VDC).

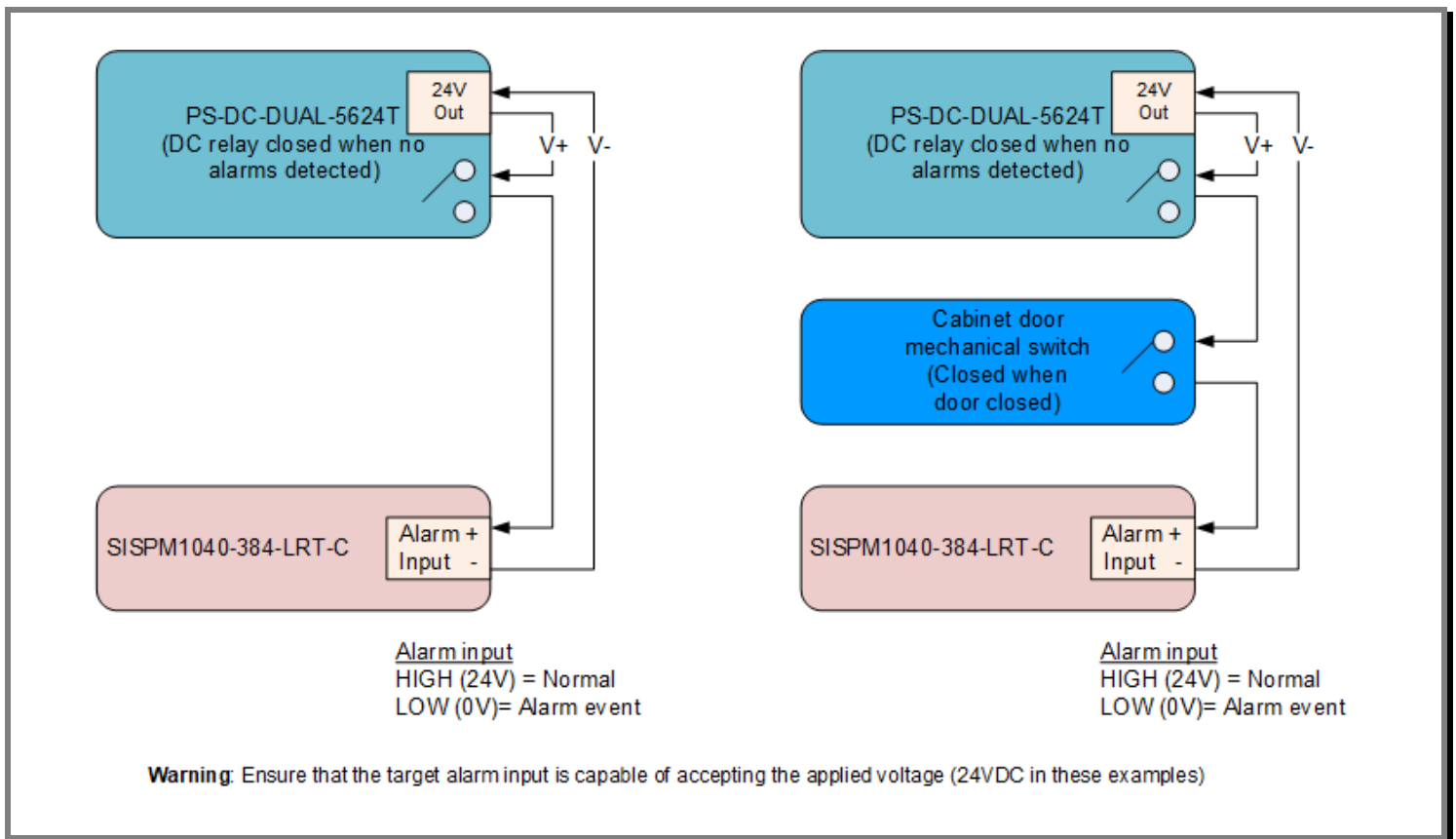

To configure Digital I/O in the SISPM1040-384-LRT-C via the Web UI:

1. Click Configuration > System > Digital I/O.
2. Specify the DI Normal Mode.
3. Enter the desired Normal and Abnormal alarm text to display in Syslog.
4. Click the Apply button.

3. Related Information

Troubleshooting

1. Check the PWR LED for status; see the [PWR \(Power\) LED](#) description on page 13.
2. Check the LED for On or alarm event blinking:
 - a. A short or overload of the 56V will be indicated by no power LED or possibly a quick On/Off cycling.
 - b. A short or overload of the 24V output will be indicated by “24VDC output out of spec” blink rate.
3. Verify the AC power source is good (a live 3-prong outlet).
4. Make sure the fuse is not blown; replace if necessary.
5. Contact Transition Networks Technical Support; see [Contact Us](#) on page 11.

Compliance Information

Declaration of Conformity

Manufacturer's Name: Transition Networks, Inc.

Manufacturer's Address: 10900 Red Circle Drive, Minnetonka, Minnesota 55343 U.S.A.

Declares that the products:

PS-DC-DUAL-5624T Standalone Power Supply

Conforms to the following Product Regulations:

FCC Part 15 Class A, EN 55032:2012, EN 55024:2010

Directive 2014/30/EU

Low-Voltage Directive 2014/35/EU

IEC /EN 60950-1:2006+A2:2013

2011/65/EU EN 50581:2012

UL 60950-1

With the technical construction on file at the above address, this product carries the **CE Mark**

I, the undersigned, hereby declare that the equipment specified above conforms to the above Directive(s) and Standards(s).

Place: Minnetonka, Minnesota

Date: July 29, 2019

Signature: *Stephen Anderson*

Full Name: Stephen Anderson

Position: Vice President of Engineering

FCC Regulations

NOTE: This equipment has been tested and found to comply with the limits for a Class A digital device, pursuant to part 15 of the FCC Rules. These limits are designed to provide reasonable protection against harmful interference when the equipment is operated in a commercial environment. This equipment generates, uses, and can radiate radio frequency energy and, if not installed and used in accordance with the instruction manual, may cause harmful interference to radio communications. Operation of this equipment in a residential area is likely to cause harmful interference in which case the user will be required to correct the interference at his own expense.

This device complies with part 15 of the FCC Rules. Operation is subject to the following two conditions: (1) This device may not cause harmful interference, and (2) this device must accept any interference received, including interference that may cause undesired operation.

Electrical Safety Warnings

Electrical Safety

IMPORTANT: This equipment must be installed in accordance with safety precautions.

Elektrische Sicherheit

WICHTIG: Für die Installation dieses Gerätes ist die Einhaltung von Sicherheitsvorkehrungen erforderlich.

Elektrisk sikkerhed

VIGTIGT: Dette udstyr skal installeres i overensstemmelse med sikkerhedsadvarslerne.

Elektrische veiligheid

BELANGRIJK: Dit apparaat moet in overeenstemming met de veiligheidsvoorschriften worden geïnstalleerd.

Sécurité électrique

IMPORTANT: Cet équipement doit être utilisé conformément aux instructions de sécurité.

Sähköturvallisuus

TÄRKEÄÄ: Tämä laite on asennettava turvaohjeiden mukaisesti.

Sicurezza elettrica

IMPORTANTE: questa apparecchiatura deve essere installata rispettando le norme di sicurezza.

Elektrisk sikkerhet

VIKTIG: Dette utstyret skal installeres i samsvar med sikkerhetsregler.

Segurança elétrica

IMPORTANTE: Este equipamento tem que ser instalado segundo as medidas de precaução de segurança.

Seguridad eléctrica

IMPORTANTE: La instalación de este equipo deberá llevarse a cabo cumpliendo con las precauciones de seguridad.

Elsäkerhet

OBS! Alla nödvändiga försiktighetsåtgärder måste vidtas när denna utrustning används.

Warranty

Five-Year Limited Hardware Warranty

Transition Networks warrants to the original consumer or purchaser that each of its PS-DC-DUAL-5624T products and all components thereof, will be free from defects in material and/or workmanship for a period of five years from the original factory shipment date. Any warranty hereunder is extended to the original consumer or purchaser and is not assignable. Transition Networks makes no express or implied warranties including, but not limited to, any implied warranty of merchantability or fitness for a particular purpose, except as expressly set forth in this warranty. In no event shall Transition Networks be liable for incidental or consequential damages, costs, or expenses arising out of or in connection with the performance of the product delivered hereunder. Transition Networks will in no case cover damages arising out of the product being used in a negligent fashion or manner.

This warranty does not cover damage from accident, acts of God, neglect, contamination, misuse or abnormal conditions of operation or handling, including over-voltage failures caused by use outside of the product's specified rating, or normal wear and tear of mechanical components.

Transition Networks will, at its option:

- Repair the defective product to functional specification at no charge
- Replace the product with an equivalent functional product
- Refund a portion of purchase price based on a depreciated value

To return a defective product for warranty coverage, contact Transition Networks' Customer Support for a return authorization number.

Send the defective product postage and insurance prepaid to the following address:

Transition Networks, Inc.

10900 Red Circle Drive

Minnetonka, MN 55343

Attn: RETURNS DEPT: CRA/RMA # _____

Failure to properly protect the product during shipping may void this warranty. The return authorization number must be written on the outside of the carton to ensure its acceptance. We cannot accept delivery of any equipment that is sent to us without a CRA or RMA number.

CRA's are valid for 60 days from the date of issuance. An invoice will be generated for payment on any unit(s) not returned within 60 days.

Upon completion of a demo/ evaluation test period, units must be returned or purchased within 30 days. An invoice will be generated for payment on any unit(s) not returned within 30 days after the demo/ evaluation period has expired.

The customer must pay for the non-compliant product(s) return transportation costs to Transition Networks for evaluation of said product(s) for repair or replacement. Transition Networks will pay for the shipping of the repaired or replaced in-warranty product(s) back to the customer (any and all customs charges, tariffs, or/and taxes are the customer's responsibility).

Before making any non-warranty repair, Transition Networks requires a \$200.00 charge plus actual shipping costs to and from the customer. If the repair is greater than \$200.00, an estimate is issued to the customer for authorization of repair. If no authorization is obtained, or the product is deemed not repairable, Transition Networks will retain the \$200.00 service charge and return the product to the customer not repaired. Non-warranted products that are repaired by Transition Networks for a fee will carry a 180-day limited warranty. All warranty claims are subject to the restrictions and conventions set forth by this document.

Transition Networks reserves the right to charge a \$50 fee for all testing and shipping incurred, if after testing, a return is classified as "No Problem Found."

THIS WARRANTY IS YOUR ONLY REMEDY. NO OTHER WARRANTIES, SUCH AS FITNESS FOR A PARTICULAR PURPOSE, ARE EXPRESSED OR IMPLIED. TRANSITION NETWORKS IS NOT LIABLE FOR ANY SPECIAL, INDIRECT, INCIDENTAL OR CONSEQUENTIAL DAMAGES OR LOSSES, INCLUDING LOSS OF DATA, ARISING FROM ANY CAUSE OR THEORY. AUTHORIZED RESELLERS ARE NOT AUTHORIZED TO EXTEND ANY DIFFERENT WARRANTY ON TRANSITION NETWORKS'S BEHALF.

Product Label and Box Label

You can find device information on the product label and box label.

Contact Us

Technical Support: is available 24-hours a day. US and Canada: 1-800-260-1312. International: 00-1-952-941-7600.

Main Office

tel: +1.952.941.7600 | toll free: 1.800.526.9267 | fax: 952.941.2322

sales@transition.com | techsupport@transition.com | customerservice@transition.com

Address

Transition Networks | 10900 Red Circle Drive | Minnetonka, MN 55343, U.S.A.

Web: <https://www.transition.com>

Record of Revisions

Rev.	Date	Description
A	7/29/19	Initial release at FW Rev. 1.0.4.
B	8/19/19	Revise specs, labels and model number.
C	9/18/19	Add power cord information.
D	11/9/21	Remove PS-DC-DUAL-5612T references and update specifications.

Trademark notice: All trademarks and registered trademarks are the property of their respective owners. All other products or service names used in this publication are for identification purposes only, and may be trademarks or registered trademarks of their respective companies. All other trademarks or registered trademarks mentioned herein are the property of their respective holders.

Copyright restrictions: © 2019-2021 Transition Networks, Inc. All rights reserved. No part of this work may be reproduced or used in any form or by any means (graphic, electronic, or mechanical) without written permission from Transition Networks.